

DT/VT 4.2  
DT/VT 4.4  
DT/VT 4.8

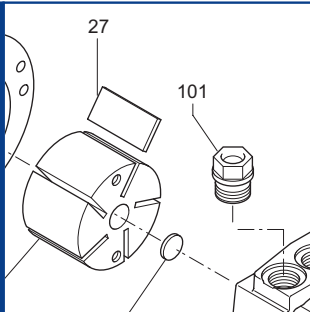

**SERVICE**

**BECKER**  
D-42279 Wuppertal  
www.becker-international.com

No. ( ) year XXXX

type VT 4.4-XX Index Variante

frequency XXXX Hz

speed XXXX min<sup>-1</sup>

power required XXXX kW

inlet capacity XXXX m<sup>3</sup>/h

pressure + XXXX mbar

vacuum - XXXX mbar

Made in Germany

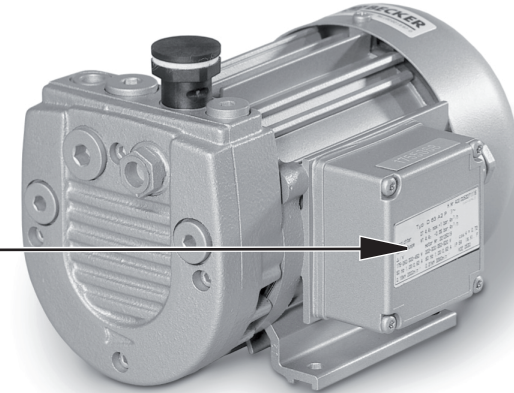

Ersatzteilliste  
Spare parts list  
Liste de pièces de rechange  
Listino pezzi di ricambio  
Lista de piezas de recambio  
Lista de peças sobresselentes  
Reserveonderdelenlijst  
Atsarginių dalių sąrašas  
Varuosad nimekirja  
Rezerves daļu saraksts

Reservedelsliste  
Reservdelslista  
Varaosuettelo  
Reservedelsliste  
Wykaz części zamiennych  
Tartalékalkatrész lista  
Seznam náhradních dílů  
Seznam nadomestnih delov  
Zoznam náhradných dielov  
Rezervni dijelovi popis

Lista pieselor de schimb  
Páirteanna spártha liosta  
Κατάλογος ανταλλακτικών  
Yedek parça listesi  
Списък на резервните части  
Перечень запасных частей  
スペアパーツリスト  
예비 부품 목록  
备用零件目录

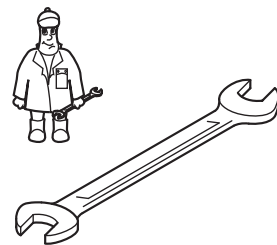

**Wartung**  
**Maintenance**  
**Entretien**  
**Manutenzione**  
**Mantenimiento**

Pos.	Menge <sup>1)</sup> Quantity Quantité Quantità Cantidad	Bestell-Nr. Ident No. No. Identification No. Identificazione No. de pedido	Bezeichnung Description Designation Designazione Descripción
<b>DT/VT 4.2 DT/VT 4.4</b>			
27	SATZ/KIT	901387 00005	Schieber, Rotor Vane, Palette, Empujador
29	1	909580 00000	Filterpatrone, Filter cartridge, Cartouche Filtrante, Cartuccia filtro, Cartucho de filtro
<b>DT/VT 4.8</b>			
27	SATZ/KIT	901388 00005	Schieber, Rotor Vane, Palette, Empujador
29	1	909581 00000	Filterpatrone, Filter cartridge, Cartouche Filtrante, Cartuccia filtro, Cartucho de filtro

<sup>1)</sup> erforderliche Bestellmenge / necessary order quantity / quantité nécessaire / quantità di ordinazione necessari / cantidad necesario

DT 4.2  
 DT 4.4  
 DT 4.8

Standard



Variante

 DT 4.2/XX  
 DT 4.4/XX  
 DT 4.8/XX

- ② /0-28
- mit Handgriff
  - with handle
  - avec poignée
  - con manetta
  - con empuñadura

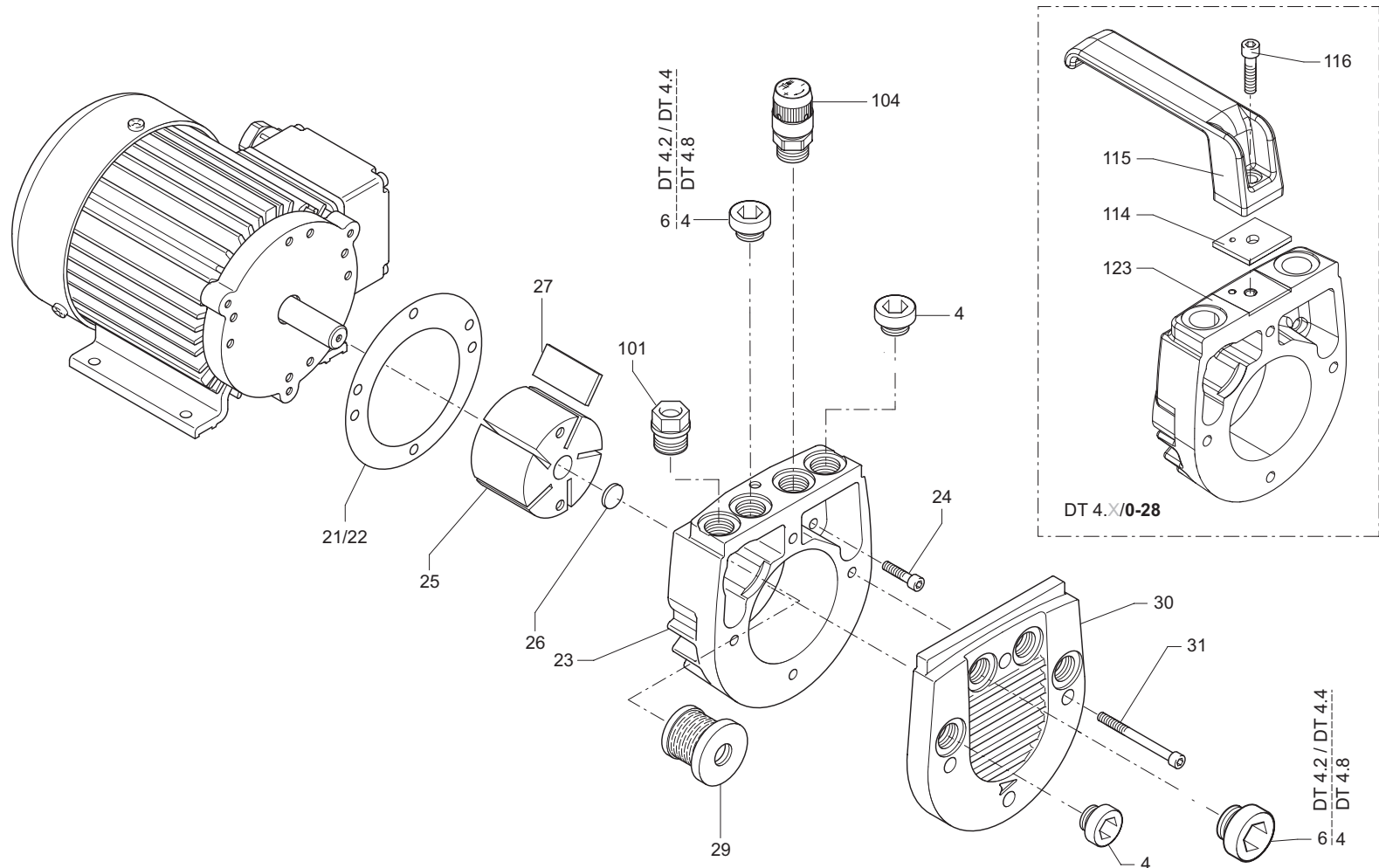

SERVICE ?

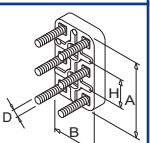
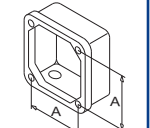
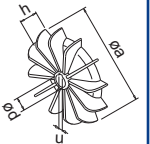
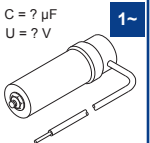
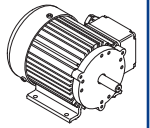

VT 4.2  
 VT 4.4  
 VT 4.8

Standard



Variante



 VT 4.2/XX  
 VT 4.4/XX  
 VT 4.8/XX

- ① /0-05
- Korrosionsschutz
  - corrosion protection
  - protection contre la corrosion
  - protezione anti-corrosione
  - protección contra la corrosión

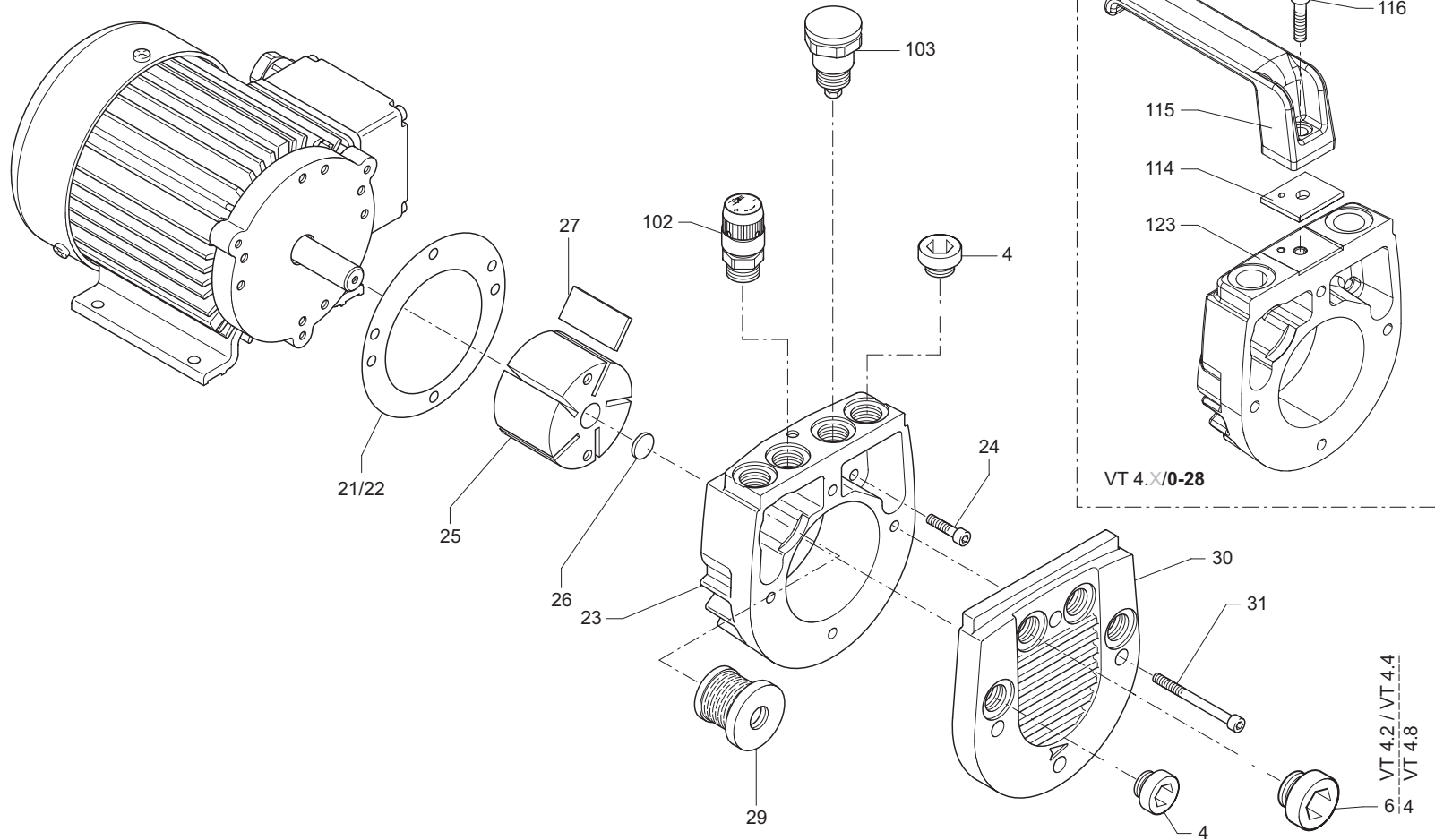
- ② /0-28
- mit Handgriff
  - with handle
  - avec poignée
  - con manetta
  - con empuñadura



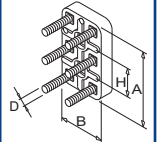
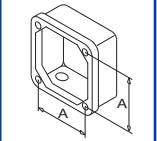
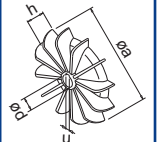
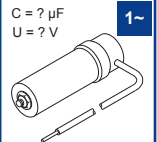
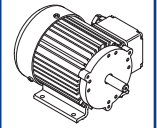

SERVICE ?



 VT 4.2 / VT 4.4  
 VT 4.8

INDEX	Pos.	Bestell Nr.	Beschreibung	
<b>DT 4.2 / DT 4.4</b>	4	951228 02000	VERSCHLUSS-SCHRAUBE G 1/4"	
	6	951228 00000	VERSCHLUSS-SCHRAUBE G 3/8"	
	21	903247 00000	DICHTUNG 0,127mm	
	22	903248 00000	DICHTUNG, VIOLETT 0,254mm	
	23	000100 27100	GEHÄUSE	
	24	945307 00000	INNENSECHSKANTSCHRAUBE	
	25	020000 27100	KOLBEN	
	26	960600 03000	RONDE	
	27	901387 00005	<b>SCHIEBER-KOHL</b> E (SATZ)	
	29	909580 00000	<b>FILTERPATRONE</b> (1x) <sup>1)</sup>	
	30	000700 27100	SEITENDECKEL	
	31	945312 00000	INNENSECHSKANTSCHRAUBE	
	101	943138 00000	SCHALLDÄMPFERDÜSE	
	104	728000 99687	DRUCKREGULIERVENTIL	
<sup>1)</sup> erforderliche Bestellmenge / Wartung				

INDEX	Pos.	Bestell Nr.	Beschreibung	
<b>VT 4.2 / VT 4.4</b>	4	951228 02000	VERSCHLUSS-SCHRAUBE G 1/4"	
	6	951228 00000	VERSCHLUSS-SCHRAUBE G 3/8"	
	21	903247 00000	DICHTUNG 0,127mm	
	22	903248 00000	DICHTUNG, VIOLETT 0,254mm	
	23	000100 27100	GEHÄUSE	
	24	945307 00000	INNENSECHSKANTSCHRAUBE	
	25	020000 27100	KOLBEN	
	26	960600 03000	RONDE	
	27	901387 00005	<b>SCHIEBER-KOHL</b> E (SATZ)	
	29	909580 00000	<b>FILTERPATRONE</b> (1x) <sup>1)</sup>	
	30	000700 27100	SEITENDECKEL	
	31	945312 00000	INNENSECHSKANTSCHRAUBE	
	102	736000 99688	VAKUUMREGULIERVENTIL	
	103	727500 99689	ABBLASEVENTIL	
<sup>1)</sup> erforderliche Bestellmenge / Wartung				

INDEX	Pos.	Bestell Nr.	Beschreibung	
<b>DT 4.8</b>	4	951228 00000	VERSCHLUSS-SCHRAUBE G 3/8"	
	21	903250 00000	DICHTUNG 0,127mm	
	22	903249 00000	DICHTUNG, VIOLETT 0,254mm	
	23	000100 27200	GEHÄUSE	
	24	945308 00000	INNENSECHSKANTSCHRAUBE	
	25	020000 27200	KOLBEN	
	26	960600 09000	RONDE	
	27	901388 00005	<b>SCHIEBER-KOHL</b> E (SATZ)	
	29	909581 00000	<b>FILTERPATRONE</b> (1x) <sup>1)</sup>	
	30	000700 27200	SEITENDECKEL	
	31	945314 00000	INNENSECHSKANTSCHRAUBE	
	101	943139 00000	SCHALLDÄMPFERDÜSE	
	104	728000 99687	DRUCKREGULIERVENTIL	
	<sup>1)</sup> erforderliche Bestellmenge / Wartung			

INDEX	Pos.	Bestell Nr.	Beschreibung	
<b>VT 4.8</b>	4	951228 00000	VERSCHLUSS-SCHRAUBE G 3/8"	
	21	903250 00000	DICHTUNG 0,127mm	
	22	903249 00000	DICHTUNG, VIOLETT 0,254mm	
	23	000100 27200	GEHÄUSE	
	24	945308 00000	INNENSECHSKANTSCHRAUBE	
	25	020000 27200	KOLBEN	
	26	960600 09000	RONDE	
	27	901388 00005	<b>SCHIEBER-KOHL</b> E (SATZ)	
	29	909581 00000	<b>FILTERPATRONE</b> (1x) <sup>1)</sup>	
	30	000700 27200	SEITENDECKEL	
	31	945314 00000	INNENSECHSKANTSCHRAUBE	
	102	736000 99688	VAKUUMREGULIERVENTIL	
	103	727500 99689	ABBLASEVENTIL	
	<sup>1)</sup> erforderliche Bestellmenge / Wartung			

INDEX	Pos.	Ident No.	Description	
DT 4.2 / DT 4.4	4	951228 02000	LOCKING SCREW G 1/4"	
	6	951228 00000	LOCKING SCREW G 3/8"	
	21	903247 00000	GASKET 0,127mm	
	22	903248 00000	GASKET, VIOLET 0,254mm	
	23	000100 27100	PUMP-BODY	
	24	945307 00000	SOCKET HEAD SCREW	
	25	020000 27100	ROTOR	
	26	960600 03000	FILLING PIECE	
	27	901387 00005	<b>CARBON VANES (KIT)</b>	
	29	909580 00000	<b>FILTER CARTRIDGE (1x) <sup>1)</sup></b>	
	30	000700 27100	LID	
	31	945312 00000	SOCKET HEAD SCREW	
	101	943138 00000	NOZZLE	
	104	728000 99687	PRESSURE REGULATING VALVE	
<sup>1)</sup> necessary order quantity / maintenance				

INDEX	Pos.	Ident No.	Description	
VT 4.2 / VT 4.4	4	951228 02000	LOCKING SCREW G 1/4"	
	6	951228 00000	LOCKING SCREW G 3/8"	
	21	903247 00000	GASKET 0,127mm	
	22	903248 00000	GASKET, VIOLET 0,254mm	
	23	000100 27100	PUMP-BODY	
	24	945307 00000	SOCKET HEAD SCREW	
	25	020000 27100	ROTOR	
	26	960600 03000	FILLING PIECE	
	27	901387 00005	<b>CARBON VANES (KIT)</b>	
	29	909580 00000	<b>FILTER CARTRIDGE (1x) <sup>1)</sup></b>	
	30	000700 27100	LID	
	31	945312 00000	SOCKET HEAD SCREW	
	102	736000 99688	VACUUM REGULATING VALVE	
	103	727500 99689	BLOW-OFF VALVE	
<sup>1)</sup> necessary order quantity / maintenance				

INDEX	Pos.	Ident No.	Description	
DT 4.8	4	951228 00000	LOCKING SCREW G 3/8"	
	21	903250 00000	GASKET 0,127mm	
	22	903249 00000	GASKET, VIOLET 0,254mm	
	23	000100 27200	PUMP-BODY	
	24	945308 00000	SOCKET HEAD SCREW	
	25	020000 27200	ROTOR	
	26	960600 09000	FILLING PIECE	
	27	901388 00005	<b>CARBON VANES (KIT)</b>	
	29	909581 00000	<b>FILTER CARTRIDGE (1x) <sup>1)</sup></b>	
	30	000700 27200	LID	
	31	945314 00000	SOCKET HEAD SCREW	
	101	943139 00000	SILENCING NOZZLE	
	104	728000 99687	PRESSURE REGULATING VALVE	
	<sup>1)</sup> necessary order quantity / maintenance			

INDEX	Pos.	Ident No.	Description	
VT 4.8	4	951228 00000	LOCKING SCREW G 3/8"	
	21	903250 00000	GASKET 0,127mm	
	22	903249 00000	GASKET, VIOLET 0,254mm	
	23	000100 27200	PUMP-BODY	
	24	945308 00000	SOCKET HEAD SCREW	
	25	020000 27200	ROTOR	
	26	960600 09000	FILLING PIECE	
	27	901388 00005	<b>CARBON VANES (KIT)</b>	
	29	909581 00000	<b>FILTER CARTRIDGE (1x) <sup>1)</sup></b>	
	30	000700 27200	LID	
	31	945314 00000	SOCKET HEAD SCREW	
	102	736000 99688	VACUUM REGULATING VALVE	
	103	727500 99689	BLOW-OFF VALVE	
	<sup>1)</sup> necessary order quantity / maintenance			

INDICE	Pos.	No. Identification	Designation
DT 4.2 / DT 4.4	4	951228 02000	BOUCHON G 1/4"
	6	951228 00000	BOUCHON G 3/8"
	21	903247 00000	JOINT 0,127mm
	22	903248 00000	JOINT, VIOLET 0,254mm
	23	000100 27100	CORP DE POMPE
	24	945307 00000	VIS HEXAGONALE INTERNE
	25	020000 27100	PISTON
	26	960600 03000	ROND EN FEUTRE
	27	901387 00005	PALETTE DE CHARBON (KIT)
	29	909580 00000	CARTOUCHE FILTRANTE (1x) <sup>1)</sup>
	30	000700 27100	COUVERCLE
	31	945312 00000	VIS HEXAGONALE INTERNE
	101	943138 00000	GICLEUR
	104	728000 99687	SOUPAPE REGLAGE PRESSION

<sup>1)</sup> quantité nécessaire / entretien

INDICE	Pos.	No. Identification	Designation
VT 4.2 / VT 4.4	4	951228 02000	BOUCHON G 1/4"
	6	951228 00000	BOUCHON G 3/8"
	21	903247 00000	JOINT 0,127mm
	22	903248 00000	JOINT, VIOLET 0,254mm
	23	000100 27100	CORP DE POMPE
	24	945307 00000	VIS HEXAGONALE INTERNE
	25	020000 27100	PISTON
	26	960600 03000	ROND EN FEUTRE
	27	901387 00005	PALETTE DE CHARBON (KIT)
	29	909580 00000	CARTOUCHE FILTRANTE (1x) <sup>1)</sup>
	30	000700 27100	COUVERCLE
	31	945312 00000	VIS HEXAGONALE INTERNE
	102	736000 99688	SOUPAPE DE REGLAGE VIDE
	103	727500 99689	SILENCIEUX

<sup>1)</sup> quantité nécessaire / entretien

INDICE	Pos.	No. Identification	Designation
DT 4.8	4	951228 00000	BOUCHON G 3/8"
	21	903250 00000	JOINT 0,127mm
	22	903249 00000	JOINT, VIOLET 0,254mm
	23	000100 27200	CORP DE POMPE
	24	945308 00000	VIS HEXAGONALE INTERNE
	25	020000 27200	PISTON
	26	960600 09000	ROND EN FEUTRE
	27	901388 00005	PALETTE DE CHARBON (KIT)
	29	909581 00000	CARTOUCHE FILTRANTE (1x) <sup>1)</sup>
	30	000700 27200	COUVERCLE
	31	945314 00000	VIS HEXAGONALE INTERNE
	101	943139 00000	GICLEUR
	104	728000 99687	SOUPAPE REGLAGE PRESSION

<sup>1)</sup> quantité nécessaire / entretien

INDICE	Pos.	No. Identification	Designation
VT 4.8	4	951228 00000	BOUCHON G 3/8"
	21	903250 00000	JOINT 0,127mm
	22	903249 00000	JOINT, VIOLET 0,254mm
	23	000100 27200	CORP DE POMPE
	24	945308 00000	VIS HEXAGONALE INTERNE
	25	020000 27200	PISTON
	26	960600 09000	ROND EN FEUTRE
	27	901388 00005	PALETTE DE CHARBON (KIT)
	29	909581 00000	CARTOUCHE FILTRANTE (1x) <sup>1)</sup>
	30	000700 27200	COUVERCLE
	31	945314 00000	VIS HEXAGONALE INTERNE
	102	736000 99688	SOUPAPE DE REGLAGE VIDE
	103	727500 99689	SILENCIEUX

<sup>1)</sup> quantité nécessaire / entretien

INDICE	Pos.	No. Identificazione	Designazione
DT 4.2 / DT 4.4	4	951228 02000	VITE DI CHIUSURA G 1/4"
	6	951228 00000	VITE DI CHIUSURA G 3/8"
	21	903247 00000	GUARNIZIONE 0,127mm
	22	903248 00000	GUARNIZIONE, VIOLA 0,254mm
	23	000100 27100	CARCASSA
	24	945307 00000	VITE ESAGONALE INTERNA
	25	020000 27100	ROTORE
	26	960600 03000	SVILUPPO CIRCOLARE IN FELTRO
	27	901387 00005	PALETTE DI CHARBONE (KIT)
	29	909580 00000	CARTUCCIA FILTRO (1x) <sup>1)</sup>
	30	000700 27100	COPERCHIO
	31	945312 00000	VITE ESAGONALE INTERNA
	101	943138 00000	UGELLO
	104	728000 99687	VALVOLA REGOLAZIONE PRESSIONE

<sup>1)</sup> quantità di ordinazione necessari / manutenzione

INDICE	Pos.	No. Identificazione	Designazione
VT 4.2 / VT 4.4	4	951228 02000	VITE DI CHIUSURA G 1/4"
	6	951228 00000	VITE DI CHIUSURA G 3/8"
	21	903247 00000	GUARNIZIONE 0,127mm
	22	903248 00000	GUARNIZIONE, VIOLA 0,254mm
	23	000100 27100	CARCASSA
	24	945307 00000	VITE ESAGONALE INTERNA
	25	020000 27100	ROTORE
	26	960600 03000	SVILUPPO CIRCOLARE IN FELTRO
	27	901387 00005	PALETTE DI CHARBONE (KIT)
	29	909580 00000	CARTUCCIA FILTRO (1x) <sup>1)</sup>
	30	000700 27100	COPERCHIO
	31	945312 00000	VITE ESAGONALE INTERNA
	102	736000 99688	VALVOLA REGOLARE VUOTO
	103	727500 99689	SILENZIATORE

<sup>1)</sup> quantità di ordinazione necessari / manutenzione

INDICE	Pos.	No. Identificazione	Designazione
DT 4.8	4	951228 00000	VITE DI CHIUSURA G 3/8"
	21	903250 00000	GUARNIZIONE 0,127mm
	22	903249 00000	GUARNIZIONE, VIOLA 0,254mm
	23	000100 27200	CARCASSA
	24	945308 00000	VITE ESAGONALE INTERNA
	25	020000 27200	ROTORE
	26	960600 09000	SVILUPPO CIRCOLARE IN FELTRO
	27	901388 00005	PALETTE DI CHARBONE (KIT)
	29	909581 00000	CARTUCCIA FILTRO (1x) <sup>1)</sup>
	30	000700 27200	COPERCHIO
	31	945314 00000	VITE ESAGONALE INTERNA
	101	943139 00000	UGELLO
	104	728000 99687	VALVOLA REGOLAZIONE PRESSIONE

<sup>1)</sup> quantità di ordinazione necessari / manutenzione

INDICE	Pos.	No. Identificazione	Designazione
VT 4.8	4	951228 00000	VITE DI CHIUSURA G 3/8"
	21	903250 00000	GUARNIZIONE 0,127mm
	22	903249 00000	GUARNIZIONE, VIOLA 0,254mm
	23	000100 27200	CARCASSA
	24	945308 00000	VITE ESAGONALE INTERNA
	25	020000 27200	ROTORE
	26	960600 09000	SVILUPPO CIRCOLARE IN FELTRO
	27	901388 00005	PALETTE DI CHARBONE (KIT)
	29	909581 00000	CARTUCCIA FILTRO (1x) <sup>1)</sup>
	30	000700 27200	COPERCHIO
	31	945314 00000	VITE ESAGONALE INTERNA
	102	736000 99688	VALVOLA REGOLARE VUOTO
	103	727500 99689	SILENZIATORE

<sup>1)</sup> quantità di ordinazione necessari / manutenzione





ÍNDICE	Pos.	No. De pedido	Descripción	
DT 4.2 / DT 4.4	4	951228 02000	TORNILLO DE CIERRE G 1/4"	
	6	951228 00000	TORNILLO DE CIERRE G 3/8"	
	21	903247 00000	JUNTA 0,127mm	
	22	903248 00000	JUNTA, VIOLETA 0,254mm	
	23	000100 27100	CARCASA	
	24	945307 00000	TORNILLO HEXAGONAL INTERIOR	
	25	020000 27100	EMBOLO	
	26	960600 03000	RODAJA	
	27	901387 00005	EMPUJADOR DE CARBÓN (KIT)	
	29	909580 00000	CARTUCHO DE FILTRO (1x) <sup>1)</sup>	
	30	000700 27100	TAPA LATERAL	
	31	945312 00000	TORNILLO HEXAGONAL INTERIOR	
	101	943138 00000	TOBERA	
104	728000 99687	VÁLVULA REGULADORA DE PRESIÓN		
<sup>1)</sup> cantidad necesario / mantenimiento				

ÍNDICE	Pos.	No. De pedido	Descripción	
VT 4.2 / VT 4.4	4	951228 02000	TORNILLO DE CIERRE G 1/4"	
	6	951228 00000	TORNILLO DE CIERRE G 3/8"	
	21	903247 00000	JUNTA 0,127mm	
	22	903248 00000	JUNTA, VIOLETA 0,254mm	
	23	000100 27100	CARCASA	
	24	945307 00000	TORNILLO HEXAGONAL INTERIOR	
	25	020000 27100	EMBOLO	
	26	960600 03000	RODAJA	
	27	901387 00005	EMPUJADOR DE CARBÓN (KIT)	
	29	909580 00000	CARTUCHO DE FILTRO (1x) <sup>1)</sup>	
	30	000700 27100	TAPA LATERAL	
	31	945312 00000	TORNILLO HEXAGONAL INTERIOR	
	102	736000 99688	VÁLVULA REGULADORA DE VACÍO	
103	727500 99689	VÁLVULA DE BARRIDO		
<sup>1)</sup> cantidad necesario / mantenimiento				

ÍNDICE	Pos.	No. De pedido	Descripción	
DT 4.8	4	951228 00000	TORNILLO DE CIERRE G 3/8"	
	21	903250 00000	JUNTA 0,127mm	
	22	903249 00000	JUNTA, VIOLETA 0,254mm	
	23	000100 27200	CARCASA	
	24	945308 00000	TORNILLO HEXAGONAL INTERIOR	
	25	020000 27200	EMBOLO	
	26	960600 09000	RODAJA	
	27	901388 00005	EMPUJADOR DE CARBÓN (KIT)	
	29	909581 00000	CARTUCHO DE FILTRO (1x) <sup>1)</sup>	
	30	000700 27200	TAPA LATERAL	
	31	945314 00000	TORNILLO HEXAGONAL INTERIOR	
	101	943139 00000	TOBERA	
	104	728000 99687	VÁLVULA REGULADORA DE PRESIÓN	
<sup>1)</sup> cantidad necesario / mantenimiento				

ÍNDICE	Pos.	No. De pedido	Descripción	
VT 4.8	4	951228 00000	TORNILLO DE CIERRE G 3/8"	
	21	903250 00000	JUNTA 0,127mm	
	22	903249 00000	JUNTA, VIOLETA 0,254mm	
	23	000100 27200	CARCASA	
	24	945308 00000	TORNILLO HEXAGONAL INTERIOR	
	25	020000 27200	EMBOLO	
	26	960600 09000	RODAJA	
	27	901388 00005	EMPUJADOR DE CARBÓN (KIT)	
	29	909581 00000	CARTUCHO DE FILTRO (1x) <sup>1)</sup>	
	30	000700 27200	TAPA LATERAL	
	31	945314 00000	TORNILLO HEXAGONAL INTERIOR	
	102	736000 99688	VÁLVULA REGULADORA DE VACÍO	
	103	727500 99689	VÁLVULA DE BARRIDO	
<sup>1)</sup> cantidad necesario / mantenimiento				



DT/VT 4.2 DT/VT 4.4 DT/VT 4.8	Variante 	Pos. <sup>2)</sup>	Bestell Nr. / Ident No. / No. Identification / No. Identificazione / No. De pedido		Beschreibung / Description / Designation / Designazione / Desripcion
					
① /0-05 - Korrosionsschutz - corrosion protection - protection contre la corrosion - protezione anti-corrosione - protección contra la corrosión		25	020001 27100	<del>020000 27100</del>	VT 4.2 + VT 4.4 ◀ KOLBEN / ROTOR / PISTON / ROTORE / ÉMBOLO
			020002 27200	<del>020000 27200</del>	VT 4.8 ◀ KOLBEN / ROTOR / PISTON / ROTORE / ÉMBOLO
② /0-28 - mit Handgriff - with handle - avec poignee - con manetta - con empuñadura		23		<del>000100 27100</del>	GEHÄUSE / PUMP BODY / CORP DE POMPE / CARCASSA / CARCASA
		114	008900 15900		DICHTUNG / GASKET / JOINT / GUARNIZIONI / ANILLO
		115	021500 15900		HANDGRIFF / HANDLE / POIGNEE / MANETTA / EMPUÑADURA
		116	945320 00000		INNENSECHSKANTSCHRAUBE / HEX HEAD SCREW / VIS HEXAGONALE INTERNE / VITE ESAGONALE INTERNA / TORNILLO HEXAGONAL INTERIOR
		123	000102 27100		GEHÄUSE / PUMP BODY / CORP DE POMPE / CARCASSA / CARCASA

<sup>2)</sup> variantenabhängige Bauteile / variant-dependent components / composants variante-dependantes / componenti variante-dispendenti / componentes variante-dependientes